



Operator's Manual

A-Series Single Temperature Unit

A D V A N C E R

— built from ambition —

Revision A

Introduction

This manual is published for informational purposes only and the information furnished herein should not be considered as all-inclusive or meant to cover all contingencies. If more information is required, consult your Thermo King Service Directory for the location and telephone number of the local dealer.

Thermo King's warranty shall not apply to any equipment which has been "so installed, maintained, repaired or altered as, in the manufacturer's judgment, to affect its integrity."

Manufacturer shall have no liability to any person or entity for any personal injury, property damage or any other direct, indirect, special, or consequential damages whatsoever, arising out of the use of this manual or any information, recommendations or descriptions contained herein. The procedures described herein should only be undertaken by suitably qualified personnel. Failure to implement these procedures correctly may cause damage to the Thermo King unit or other property or personal injury.

There is nothing complicated about operating and maintaining your Thermo King unit, but a few minutes studying this manual will be time well spent.

Performing pre-trip checks and enroute inspections on a regular basis will minimize operating problems. A regular maintenance program will also help to keep your unit in top operating condition. If factory recommended procedures are followed, you will find that you have purchased the most efficient and dependable temperature control system available.

All service requirements, major and minor, should be handled by a Thermo King dealer for four very important reasons:

- They are equipped with the factory recommended tools to perform all service functions
- They have factory trained and certified technicians
- They have genuine Thermo King replacement parts
- The warranty on your new unit is valid only when the repair and replacement of component parts is performed by an authorized Thermo King dealer

Machine Information Policy

Use of this product serves as acceptance of the Thermo King Machine Information Policy available at: www.europe.thermoking.com. This product includes a standard feature that collects and shares Machine Information with Thermo King. Separate terms may apply when a customer has entered into an agreement with Thermo King. Customers that would like to opt-out of sharing Machine Information with Thermo King should forward such inquiries to the email address Opt-Out@ThermoKing.com.

Software License

The product includes software that is licensed under a non-exclusive, non-sublicensable, terminable and limited license to use the software as installed on the product for its intended purpose. Any removal, reproduction, reverse engineering, or other unauthorized use of the software is strictly prohibited. Hacking the product or installing unapproved software may void the warranty. The owner or operator shall not reverse engineer, decompile, or disassemble the software, except and only to the extent that such activity is expressly permitted by applicable law notwithstanding this limitation. The product may include third party software separately licensed as specified in any documentation accompanying the product or in an about screen on a mobile application or website that interfaces with the product.

Emergency Assistance

Thermo Assistance is a multi-lingual communication tool designed to put you in direct contact with an authorized Thermo King dealer.

Thermo Assistance should only be contacted for breakdown and repair assistance.

To use this system, you need the following information before you call: (phone charges will apply)

- Contact Phone Number
- Type of TK Unit
- Thermostat Setting
- Present Load Temperature
- Probable Cause of Fault
- Warranty Details of the Unit
- Payment Details for the Repair

Introduction

Leave your name and contact number and a Thermo Assistance Operator will call you back. At this point you can give details of the service required and the repair will be organized.

Please note that Thermo Assistance cannot guarantee payments and the service is designed for the exclusive use of refrigerated transporters with products manufactured by Thermo King Corporation.



Belgium	+32 270 01 735
Denmark	+45 38 48 76 94
France	+33 171 23 05 03
Germany	+49 695 00 70 740
Italy	+39 02 69 63 32 13
Spain	+34 914 53 34 65
The Netherlands	+31 202 01 51 09
United Kingdom	+44 845 85 01 101
Kazakhstan	+7 7273458096
Russia	+7 4992718539
Others	+32 270 01 735

BEA261

General Inquires and Unit Maintenance

For general inquiries please contact your local Thermo King dealer.

Go to www.europe.thermoking.com and select dealer locator for your local Thermo King dealer.

Or refer to the Thermo King Service Directory for contact information.

Customer Satisfaction Survey

Let your voice be heard!

Your feedback will help improve our manuals. The survey is accessible through any internet-connected device with a web browser.

Scan the Quick Response (QR) code or click or type the web address https://tranetechnologies.iad1.qualtrics.com/jfe/form/SV_2octfSHoUJxsk6x?Q_CHL=qr&Q_JFE=qdg to complete the survey.



Table of Contents

Safety	10
Danger, Warning, Caution, and Notice.....	10
General Safety Practices	11
Automatic Start/Stop Operation.....	11
Battery Installation and Cable Routing	12
Refrigerant.....	14
Refrigerant Oil.....	15
First Aid.....	15
Safety Decals and Locations	17
Operation	17
Condenser and Evaporator Fans.....	17
Refrigerant and Compressor Oil.....	18
Electrical Warnings.....	19
Unit Description	20
General Information	20
Diesel Engine.....	21
Extended Life Coolant (ELC)	21
EMI 3000.....	22
Thermo King Reciprocating Compressor.....	22
Electronic Throttling Valve	22
A-Series Controller Control System	23
CYCLE-SENTRY™ Stop-Start Operation.....	23
Continuous Run Operation.....	23
Telematics as Standard	23
Further Communication Capabilities.....	24
Defrost	24

Engine Compartment	25
Opening the Front Doors	26
Unit Protection Devices	27
Manual Pretrip Inspection	29
A-Series Controller Overview	32
Highlights of the A-Series Controller	32
Microprocessor On/Off Switch	33
HMI Control Panel	34
Hard Keys	35
Soft Keys	35
Navigation Keys	36
Accept/Enter Key	36
Standard Display	37
Temperature Watch Display	38
Dashboard	39
Main Menu	40
Operating Instructions	41
Turning Unit On	41
Turning Unit Off	44
Language Selection	45
Operating Software	46
Flash Loading	46
Continuous Mode	47
Cycle-Sentry Mode	48
Fuel Gauge	51
Switching from Diesel to Electric Operation	52

Switching from Electric to Diesel Operation	55
Changing the Setpoint	57
Defrost Mode	59
Frozen Mode	61
Fresh Mode.....	62
Heat Mode	63
Null / Running Null	64
Alarms.....	65
Information Alarms	66
Check Alarms.....	66
Shutdown Alarms.....	66
Piek Active Mode	68
Main Menu+ Display	69
Details	69
Connecting to a Third Party Device.....	70
Printing a Trip Report	71
Loading and Inspection Procedures.....	73
Pre-Loading Inspection.....	73
Post-Loading Inspection.....	75
Enroute Inspections.....	75
Inspection Procedure	75
Inspection Troubleshooting	75
Specifications	78
Engine	78
Filters.....	80
Refrigeration System	80
Electrical Control System.....	80

Electric Motor	80
Standby Power Requirements	80
TrackKing	81
Jump Starting	82
Warranty.....	86
Maintenance Inspection Schedule	87
Inspection and Service Intervals	87
Serial Number Locations	88
Recover Refrigerant.....	89

Safety

Danger, Warning, Caution, and Notice

Thermo King® recommends that all service be performed by a Thermo King dealer and to be aware of several general safety practices.

Safety advisories appear throughout this manual as required (refer to examples below). Your personal safety and the proper operation of this unit depend upon the strict observance of these precautions.

▲ DANGER

Example!

Indicates an imminently hazardous situation which, if not avoided, will result in death or serious injury.

▲ WARNING

Example!

Indicates a potentially hazardous situation which, if not avoided, could result in death or serious injury.

▲ CAUTION

Example!

Indicates a potentially hazardous situation which, if not avoided, could result in minor or moderate injury and unsafe practices.

NOTICE

Example!

Indicates a situation that could result in equipment or property-damage only accidents.

General Safety Practices



⚠ DANGER

Risk of Injury!

Keep hands and loose clothing clear of fans and belts at all times when the unit is operating with the doors open.

⚠ WARNING

Risk of Injury!

Do not apply heat to a closed cooling system. Before applying heat to a cooling system, drain it. Then flush it with water and drain the water. Antifreeze contains water and ethylene glycol. The ethylene glycol is flammable and can ignite if the antifreeze is heated enough to boil off the water.

⚠ WARNING

Risk of Injury!

Temperatures above 120 degrees F (50 degrees C) can cause serious burns. Use an infrared thermometer or other temperature measuring device before touching any potentially hot surfaces.

⚠ CAUTION

Sharp Edges!

Exposed coil fins can cause lacerations. Service work on the evaporator or condenser coils is best left to a certified Thermo King technician.

Automatic Start/Stop Operation



⚠ CAUTION**Risk of Injury!**

The unit can start and run automatically any time the unit is turned on. Turn the Microprocessor On/Off switch Off before doing inspections or working on any part of the unit. Please note that only Qualified and Certified personnel should attempt to service your Thermo King unit.

Battery Installation and Cable Routing**⚠ WARNING****Hazard of Explosion!**

An improperly installed battery could result in a fire, explosion, or injury. A Thermo King approved battery must be installed and properly secured to the battery tray.

⚠ WARNING**Hazard of Explosion!**

Improperly installed battery cables could result in a fire, explosion, or injury. Battery cables must be installed, routed, and secured properly to prevent them from rubbing, chaffing, or making contact with hot, sharp, or rotating components.

⚠ WARNING**Fire Hazard!**

Do not attach fuel lines to battery cables or electrical harnesses. This has the potential to cause a fire and could cause serious injury or death.



⚠ WARNING

Hazard of Explosion!

Always cover battery terminals to prevent them from making contact with metal components during battery installation. Battery terminals grounding against metal could cause the battery to explode.

⚠ CAUTION

Hazardous Service Procedures!

Set all unit electrical controls to the OFF position before connecting battery cables to the battery to prevent unit from starting unexpectedly and causing personal injury.

NOTICE

Equipment Damage!

Do not connect other manufacturer's equipment or accessories to the unit unless approved by Thermo King. Failure to do so can result in severe damage to equipment and void the warranty.

Refrigerant



Although fluorocarbon refrigerants are classified as safe, use caution when working with refrigerants or in areas where they are being used.

⚠ DANGER

Hazardous Gases!

Refrigerant in the presence of an open flame, spark, or electrical short produces toxic gases that are severe respiratory irritants which can cause serious injury or possible death.

⚠ DANGER

Refrigerant Vapor Hazard!

Do not inhale refrigerant. Use caution when working with refrigerant or a refrigeration system in any confined area with a limited air supply. Refrigerant displaces air and can cause oxygen depletion, resulting in suffocation and possible death.

⚠ WARNING

Personal Protective Equipment (PPE) Required!

Refrigerant in a liquid state evaporates rapidly when exposed to the atmosphere, freezing anything it contacts. Wear butyl lined gloves and other clothing and eye wear when handling refrigerant to help prevent frostbite.

Refrigerant Oil



Observe the following precautions when working with or around refrigerant oil:

⚠ WARNING

Personal Protective Equipment (PPE) Required!

Protect your eyes from contact with refrigerant oil. The oil can cause serious eye injuries. Protect skin and clothing from prolonged or repeated contact with refrigerant oil. To prevent irritation, wash your hands and clothing thoroughly after handling the oil. Rubber gloves are recommended.

First Aid

REFRIGERANT

- **Eyes:** For contact with liquid, immediately flush eyes with large amounts of water and get prompt medical attention.
- **Skin:** Flush area with large amounts of warm water. Do not apply heat. Remove contaminated clothing and shoes. Wrap burns with dry, sterile, bulky dressing to protect from infection. Get prompt medical attention. Wash contaminated clothing before reuse.
- **Inhalation:** Move victim to fresh air and use Cardio Pulmonary Resuscitation (CPR) or mouth-to-mouth resuscitation to restore breathing, if necessary. Stay with victim until emergency personnel arrive.
- **Frost Bite:** In the event of frost bite, the objectives of First Aid are to protect the frozen area from further injury, warm the affected area rapidly, and to maintain respiration.

REFRIGERANT OIL

- **Eyes:** Immediately flush with large amounts of water for at least 15 minutes. Get prompt medical attention.
- **Skin:** Remove contaminated clothing. Wash thoroughly with soap and water. Get medical attention if irritation persists.

Safety

- **Inhalation:** Move victim to fresh air and use Cardio Pulmonary Resuscitation (CPR) or mouth-to-mouth resuscitation to restore breathing, if necessary. Stay with victim until emergency personnel arrive.
- **Ingestion:** Do not induce vomiting. Immediately contact local poison control center or physician.

ENGINE COOLANT

- **Eyes:** Immediately flush with large amounts of water for at least 15 minutes. Get prompt medical attention.
- **Skin:** Remove contaminated clothing. Wash thoroughly with soap and water. Get medical attention if irritation persists.
- **Ingestion:** Do not induce vomiting. Immediately contact local poison control center or physician.

BATTERY ACID

- **Eyes:** Immediately flush with large amounts of water for at least 15 minutes. Get prompt medical attention. Wash skin with soap and water.

ELECTRICAL SHOCK

Take IMMEDIATE action after a person has received an electrical shock. Get quick medical assistance, if possible.

The source of the shock must be quickly stopped, by either shutting off the power or removing the victim. If the power cannot be shut off, the wire should be cut with a non-conductive tool, such as a wood-handle axe or thickly insulated cable cutters. Rescuers should wear insulated gloves and safety glasses, and avoid looking at wires being cut. The ensuing flash can cause burns and blindness.

If the victim must be removed from a live circuit, pull the victim away with a non-conductive material. Use wood, rope, a belt or coat to pull or push the victim away from the current. DO NOT TOUCH the victim. You will receive a shock from current flowing through the victim's body. After separating the victim from power source, immediately check for signs of a pulse and respiration. If no pulse is present, start Cardio Pulmonary Resuscitation (CPR). If a pulse is present, respiration might be restored by using mouth-to-mouth resuscitation. Call for emergency medical assistance.

ASPHYXIATION

Move victim to fresh air and use Cardio Pulmonary Resuscitation (CPR) or mouth-to-mouth resuscitation to restore breathing, if necessary. Stay with victim until emergency personnel arrive.

Safety Decals and Locations

Operation

The Operation decal is located on your HMI or rear remote controller (if fitted). This decal gives you the information to access/download your unit operator manual and other supporting documentation and in many supported languages.

Figure 1. Operation Decal

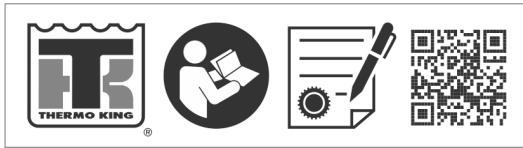

BEN525

Condenser and Evaporator Fans

Be aware of warning nameplates in the following locations:

- On bulkhead
- On belt guard
- On rear of evaporator housing

Figure 2. Fan Warning Nameplate

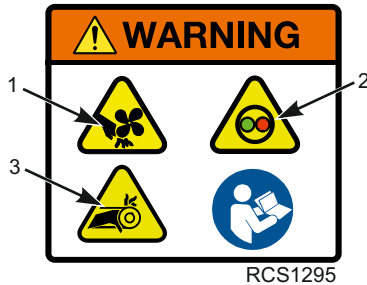

1.	<p>Rotating Fans: Risk of Injury! Caution Rotating Fan blade operating. Keep hands, hair, cloths and all object clear. Prior to completing any inspections or working on any part of the unit</p> <ol style="list-style-type: none"> 1. Press the OFF key on the HMI control panel. 2. Open the engine bay doors. 3. Turn the On/Off switch to the "Off" position.
2.	<p>Automatic Start/Stop Operation: Risk of Injury! The unit can start and run automatically any time without warning. Prior to completing any inspections or working on any part of the unit</p> <ol style="list-style-type: none"> 1. Press the OFF key on the HMI control panel. 2. Open the engine bay doors. 3. Turn the On/Off switch to the "Off" position.
3.	<p>Rotating belt: Risk of Injury! Rotating belt. Keep clear. Prior to completing any inspections or working on any part of the unit</p> <ol style="list-style-type: none"> 1. Press the OFF key on the HMI control panel. 2. Open the engine bay doors. 3. Turn the On/Off switch to the "Off" position.

Refrigerant and Compressor Oil

Refrigerant nameplate is located on frame inside door.

Figure 3. Refrigerant and Compressor Oil Nameplate



RCS1303

Electrical Warnings

Figure 4. Magnetic Warning Nameplate



RCS1302

Figure 5. High Voltage Warning Nameplate



RCS1304

Unit Description

General Information

This Thermo King A-Series unit is a one piece, self-contained, diesel/electric powered cooling/heating trailer unit. The unit mounts on the front of the trailer with the evaporator extending through an opening in the front wall. It features a fully programmable microprocessor controller designed exclusively for transport refrigeration applications, all-new DDE (Diesel Direct Electric) architecture, a quiet running Thermo King diesel engine, and a Thermo King X430 reciprocating compressor.

Figure 6. Thermo King A-Series Unit Shown

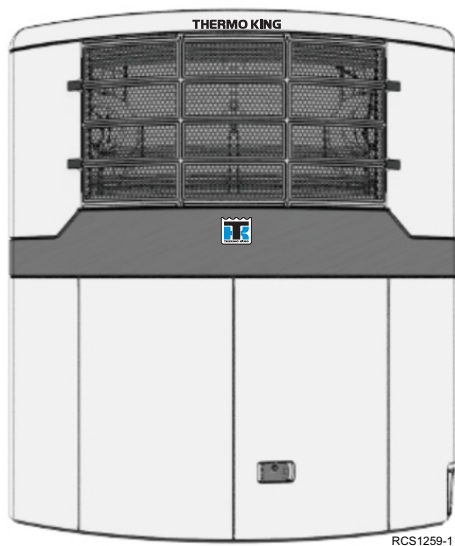

Diesel Engine

This trailer unit uses a 4-cylinder, water cooled, direct injection diesel engine. The engine is coupled to the compressor with a centrifugal clutch. The pulley on the clutch is connected by a belt that transfers power to a generator/electric motor combination that supply's DC current to operate the 12VDC and 48VDC electrical systems. A second belt operates the engine's water pump.

This trailer unit complies with 2016/1628 EU regulation (or NRMM Stage V). To determine if an engine is NRMM Stage 5 compliant, the engine model shall be stated on the engine serial plate (located on engine behind trailer service doors). See below an example of engine serial plate

Figure 7. Engine Serial Plate for NRMM

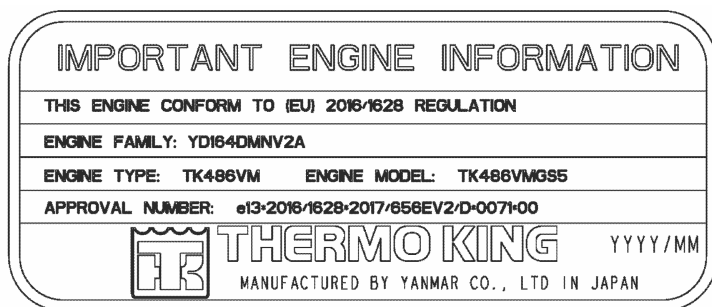

BEN578

Extended Life Coolant (ELC)

ELC (Extended Life Coolant) is standard equipment. The maintenance interval for ELC is five years or 12,000 hours. A nameplate on the coolant expansion tank identifies units with ELC. The new engine coolant, Chevron Extended Life Coolant, is RED in color instead of the previous GREEN or BLUE-GREEN colored conventional coolants.

NOTICE

System Contamination!

Do not add "GREEN" or "BLUE-GREEN" conventional coolant to cooling systems using "RED" Extended Life Coolant, except in an emergency. If conventional coolant is added to Extended Life Coolant, the coolant must be changed after 2 years instead of 5 years.

Unit Description

Note: *The use of 50/50 percent pre-mixed Extended Life Coolant (ELC) is recommended to assure that de-ionized water is being used. If 100 percent full strength concentrate is used, de-ionized or distilled water is recommended over tap water to insure the integrity of the cooling system is maintained.*

EMI 3000

EMI 3000 is an extended maintenance interval package. It is standard equipment. The EMI 3000 package consists of the following key components:

- EMI 3000-Hour Cyclonic Air Cleaner Assembly and Air Cleaner Element
- EMI 5-Micron 3000-Hour Fuel Filter
- EMI 3000-Hour Dual Element Oil Filter
- API Rating CI-4 Mineral Oil
- Five Year or 12,000 Hour ELC (Extended Life Coolant)

The EMI package allows standard maintenance intervals for air cleaner, air cleaner element, fuel filter and dual element oil filter to be extended to 3,000 hours, or 2 years, whichever occurs first.

Note: *Units equipped with the EMI 3000 package do require regular inspection in accordance with Thermo King's maintenance recommendations.*

Thermo King Reciprocating Compressor

This trailer unit is equipped with a 4-cylinder 30.0 cu. in. (492 cm³) displacement Thermo King X430 reciprocating compressor.

Electronic Throttling Valve

The Electronic Throttling Valve (ETV) provides enhanced control of the refrigeration system as follows:

- Allows the refrigeration system to fully utilize the power capabilities of the engine under varying conditions.
- Provides an additional measure of protection against high discharge pressures.
- Protects the engine from high coolant temperature shutdowns.
- Provides a means of precise temperature control.

A-Series Controller Control System

Thermo King's A-Series Controller is a microprocessor control system designed exclusively for a transport refrigeration system. The A-Series Controller's integrated HMI (Human Machine Interface) control panel allows the operator to perform the following functions:

- Power Up and Power Down Unit
- Display and Change Language
- Display and Change Setpoint
- Display and Initiate Defrost
- Display System Status of Engine, Refrigeration, Power and Control
- Display and Clear Alarms

The unit will operate in either Cycle-Sentry or Continuous Run mode of operation as selected by the operator using the HMI Control Panel.

See "Operating Instructions" for more information about the A-Series Controller.

CYCLE-SENTRY™ Stop-Start Operation

The CYCLE-SENTRY Start-Stop fuel saving system provides optimum operating economy. When CYCLE-SENTRY Mode is selected the unit will start and stop automatically to maintain setpoint and the battery charged.

Continuous Run Operation

When Continuous Mode is selected, the unit starts automatically and runs continuously to maintain setpoint and provide constant airflow.

Telematics as Standard

TracKing: These units come with TracKing communication device and Bluetooth® as standard.

Note: *Your unit may not have a standard configuration and therefore may not include this facility. Please contact your Thermo King Dealer for more information.*

You can also download from your App store the appropriate App to connect, and manage your unit from your mobile device. Please contact your Thermo King Representative for more information. Refer to ("[Specifications](#)," p. 78) for Specifications.

This trailer unit is equipped with TracKing Connected Solutions communication device that when enabled allows remote access to unit data.

Unit Description

Downloading the Thermo King Reefer mobile app, will allow you to monitor and manage temperature and reefer settings over the road, in the yard or in-cab via Bluetooth®. Contact your Thermo King representative for more information about all the features and options available with TrackKing Connected Solutions.

Further Communication Capabilities

Cable connection: when using a laptop with WinTrac™ software.

Plug&Play Log Download: Facilitates direct download of files - CSV, Pdf – on a USB memory stick without having to format it to WinTrac.

Service Log: Service Log is a standard Log on this unit. It records operating events, alarm codes, and compartment temperatures as they occur and at preset intervals. This information is typically used to analyze unit performance. Use a USB port to download the Service Log data.

Important: *A Service Log download can be helpful when diagnosing a problem. Therefore, it is recommended that a Service Log download be performed to help diagnose a problem. A Service Log download must be performed before contacting the Thermo King Service Department for assistance in diagnosing a problem.*

Compliance Log: Compliance Log data logging requires the installation of an optional sensor. Four door switches can be installed also. Compliance Log also logs the setpoint. Use the Compliance Log Port to download the Compliance Log data. If optional temperature sensors are installed, the readings are displayed as Datalogger Sensor (1 or 2) Temperature in the sensor readings.

Printer Port: This port is used to print trip records from the Compliance Log. It is located inside the control box.

USB key: via the USB port provided as standard, eliminating the need for laptops and cables.

GPRS connection: via TrackKing™ tool which allows online fleet and temperature management.

Wireless communication: As end customers demand increasing temperature traceability, transporters need a simple and effective means of accessing critical data.

Defrost

Frost gradually builds-up on evaporator coils as a result of normal operation. The unit uses hot refrigerant to defrost the evaporator coil. Hot refrigerant

gas passes through the evaporator coil and melts the frost. The water flows through collection drain tubes onto the ground. The methods of defrost initiation are Automatic and Manual.

Automatic Defrost: The SR-3 automatically initiates timed or demand defrost cycles. The HMI can be programmed to initiate timed defrost cycles at intervals of 2, 4, 6, 8, or 12 hours. Demand defrost cycles occur if the differences between the return air temperature, discharge air temperature, and coil temperature exceed certain limits. The unit can enter defrost cycles as often as every 30 minutes if required.

Manual Defrost: In Manual Defrost mode, the operator initiates a defrost cycle. Refer to (“Defrost Mode,” p. 59).”

Note: *The unit will not perform a Manual Defrost Cycle unless the unit has been turned on with the ON key, the unit is running in Continuous or CYCLE-SENTRY Mode (or shut down in CYCLE-SENTRY Null Mode), and the coil temperature is below 45°F (7°C)7°C (45°F).*

Engine Compartment

WARNING

Risk of Injury!

The unit can start at any time without warning. Press the OFF key on the HMI control panel and place the microprocessor On/Off switch in the Off position before inspecting or servicing any part of the unit.

CAUTION

Service Procedures!

Turn the unit off before attempting to check the engine oil.

The following maintenance items can be checked visually.

Engine Oil Dipstick: Use the engine oil dipstick to check the engine oil level.

Opening the Front Doors

To open the front doors to access the engine compartment, pull the door handle out. To close the door, push the door shut and latch the handle securely.

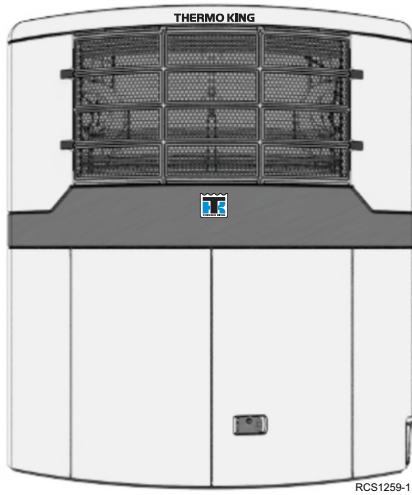

Unit Protection Devices

Preheat Buzzer: The preheat buzzer sounds when the controller energizes the preheat relay. This warns anyone near the unit that the controller is about to start the engine.

Coolant Level Switch: The coolant level switch closes if the coolant level drops below an acceptable level. If it stays closed for a specified time, the microprocessor records and alarm code.

Engine Coolant Temperature Sensor: The microprocessor uses the engine coolant temperature sensor to monitor the engine coolant temperature. If the engine coolant temperature rises above an acceptable level, the microprocessor records and alarm code. The microprocessor might also shut the unit down.

High Pressure Cutout Switch: The high pressure cutout switch is located on the compressor discharge manifold. If the compressor discharge pressure becomes excessive, the switch opens the circuit to the run relay to stop the unit. The microprocessor will record an alarm code.

High Pressure Relief Valve: This valve is designed to relieve excessive pressure in the refrigeration system. It is located on the receiver tank. If the high pressure relief valve opens, much of the refrigerant will be lost. Take the unit to a Thermo King dealer if this occurs.

Low Oil Level Switch: The low oil level switch closes if the oil drops below an acceptable level. If it stays closed for a specified time, the microprocessor shuts the unit down and records an alarm code.

Low Oil Pressure Switch: The low oil pressure switch closes if the oil pressure drops below an acceptable level. If it stays closed for a specified time, the microprocessor shuts the unit down and records an alarm code.

Overload Relay - Automatic Reset (Electric Standby units): An overload relay protects the standby electric motor/generator. The overload relay opens the circuit to the electric motor if the motor overloads for any reason (e.g., low line voltage or improper power supply) while the unit is on electric standby operation. The microprocessor will record an alarm code.

Smart FETs: Smart FETs in the microprocessor protect some circuits and components from an overcurrent condition.

Fuses: Fuses are located in harnesses and in the Power Distribution Module (PDM). All fuses must be serviced only by qualified Thermo King technicians. Contact your nearest Thermo King Dealer for assistance.

THERMO KING
Unit Description

Table 1. 12 Volt Fuses in Harness

Fuse	Size	Function
	60A	Air Heater
	40A	Charge Supply
	40A	Starter Solenoid
	20A	LPM (Low Power Module)
	20A	HPM (High Power Module)

Table 2. 48 Volt Fuses in PDM

Fuse	Size	Function
F8	20A	Blowers Condenser Roadside
F10	20A	Blowers Condenser Curbside
F12	20A	DC Charger
F14	20A	Blowers Evaporator Roadside
F16	20A	Blowers Evaporator Curbside

Table 3. 12 Volt Fuses in PDM

Fuse	Size	Function
F1	5A	BlueBox Power Out
F2	5A	LPM Power Out
F3	3A	3rd Party Power Out
F4	5A	PSM Power Out
F5	5A	HMI Power Out
F6	5A	Printer Power Out
F7	10A	ECU Power Out

Manual Pretrip Inspection

Pretrip inspections are an important part of a preventative maintenance program designed to minimize operating problems and breakdowns. Perform this pretrip inspection before every trip involving refrigerated cargo.

Note: *Pretrip inspections are not intended to take the place of regular maintenance inspections.*

Fuel: Verify the diesel fuel supply is adequate to guarantee engine operation to the next check point. Allow for maximum fuel consumption of 3.8 Litres (one gallon) per hour of engine operation.

CAUTION

Service Procedures!

Turn the unit off before attempting to check the engine oil.

Engine Oil: Check the engine oil level. It should be at the Full mark when the dipstick is threaded all the way into the oil pan. Do not overfill.

CAUTION

Hazardous Pressures!

Do not remove expansion tank cap while coolant is hot.

Engine Coolant: The engine coolant must have antifreeze protection to -34 C (-30 F). Add coolant if alarm code s active. Check and add coolant to the expansion tank.

Battery: Verify the battery terminals are tight and free of corrosion.

Manual Pretrip Inspection

Note: *All truck and trailer units will have a small battery drain when the unit is off. The battery can be drained even quicker if there are aftermarket options or third party devices connected to the unit which consume battery power.*

This will cause the battery to become discharged over time.

Apart from the obvious inconvenience of having to charge the battery, it is also liable to damage battery cell material and cause the life of the battery to be shorter than acceptable.

Therefore, to ensure the battery remains in optimum condition during periods when the unit is not being used, Thermo King strongly recommends to switch on the unit at least once each week and run for 30 minutes or longer.

If the EnergyONE battery is drained after a long idle period, it will need to be recharged using an automatic programmable battery charger (Thermo King does not recommend the use of manual battery chargers on dry cell batteries).

Failure to do so may result in warranty for the battery being rejected.

Alternatively, Thermo King offers a solar panel option which would negate the requirement to switch off the microprocessor switch during long unit idle periods. For more information, please contact your local Thermo King dealership.

Belts: Verify belts are in good condition and adjusted to the proper tension. For more information about belt tension, see the Specifications chapter.

Electrical: Check the electrical connections to verify they are securely fastened. Wires and terminals should be free of corrosion, cracks, and moisture.

Structural: Visually inspect the unit for leaks, loose or broken parts, and other damage.

Coils: Verify condenser and evaporator coils are clean and free of debris.

- Washing with clean water should be sufficient.
- The use of cleaning agents or detergents is strongly discouraged due to the possibility of degradation of the construction.
- If using a power washer, the nozzle pressure should not exceed 600 psi (41 bar). For the best results, spray the coil perpendicular to the face of the coil. The spray nozzle should be kept between 1 inch and 3 inches (25 to 75 millimeters) from the coil surface.
- If necessary to use a chemical cleaner or detergent, use a cleaner that does not contain any hydrofluoric acids and is between 7 and 8 on the pH

scale. Verify dilution instructions provided by the detergent supplier are followed. In case of doubt about the compatibility of the detergent with the type of materials listed above, always ask the supplier a written confirmation of the compatibility.

- Should a chemical cleaner be required, it is **MANDATORY** that all components are thoroughly rinsed with water even if the instructions of the cleaner specify that it is a “no rinse” cleaner.

NOTICE

Equipment Damage!

Failure to comply with above mentioned guidelines will lead to a shortened life of the equipment to an indeterminable degree and also may void your warranty.

Note: *The repeated transportation of meat and fish waste can cause extensive corrosion to the evaporator coils and evaporator section tubing over time due to ammonia formation and can reduce the lifespan of the coils. Appropriate additional measures should be taken to protect the coils against the aggressive corrosion that can result from transportation of such products.*

Cargo Box: Check the interior and exterior of the cargo box for damage. Any damage to the walls or insulation must be repaired.

Note: *On trailers equipped with units qualified for pharmaceutical applications - under ThermoKing protocol inspect the integrity of the air chute.*

Cargo Doors: Verify the cargo doors and weather seals are in good condition. The doors should latch securely and the weather seals should fit tightly.

Defrost Drains: Check the defrost drain hoses to verify they are open and are equipped with one way kazoo valves at the drain exit.

A-Series Controller Overview

Thermo King has applied the latest advances in computer technology to develop a device that controls temperature and unit function, and displays operating information quickly and accurately.

There is nothing complicated about learning to operate the A-Series Controller, but you will find that a few minutes studying the contents of this manual will be time well spent.

Figure 8. A-Series Controller



Highlights of the A-Series Controller

New Software and Controller

- Software developed by Thermo King.
- Hardware Developed with a Global Leader in rugged electronics.

Improvements

- Intuitive interface similar to a mobile face
- Bigger screen size with higher resolution and colors
- All in one screen display dashboard
- Icon based Interface
- Improved ease of use
- Superior Controls

- Fully accessible and visible HMI orientation angle.

Microprocessor On/Off Switch

The microprocessor On/Off switch is located behind the lower roadside panel inside the engine compartment. This switch supplies or removes all electrical power to the microprocessor control system and all electrical circuits.

The switch must be in the ON position for the unit to operate.

The switch should be placed in the OFF position only when servicing the unit or if the unit is not going to be operated for one week or longer. Placing the switch in the OFF position will help prevent parasitic battery voltage loss and a dead battery.

Figure 9. Microprocessor On/Off Switch

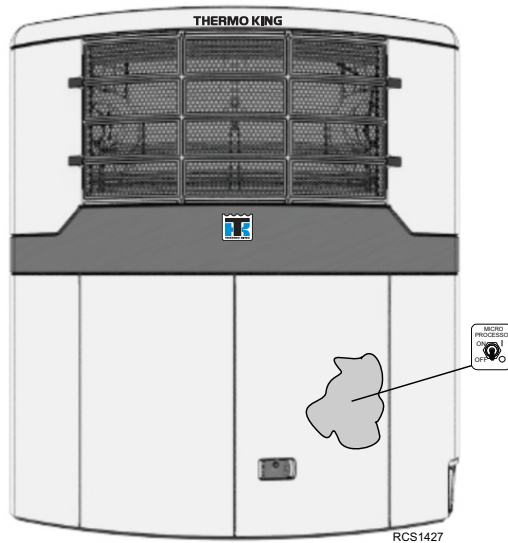

HMI Control Panel

⚠ CAUTION

Risk of Injury!!

Do not operate the HMI Control Panel until you are completely familiar with its function.

The A-Series Controller HMI (Human Machine Interface) control panel is used to operate the unit. The HMI has a display and twelve touch sensitive keys. The display is capable of showing both text and graphics.

Figure 10. HMI Control Panel Details

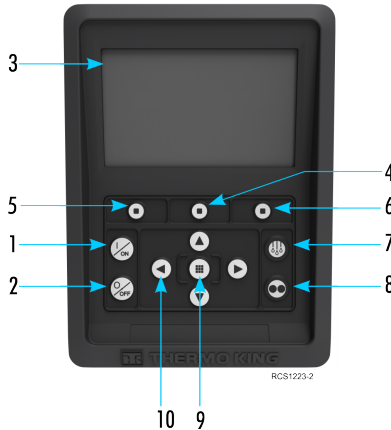

Keypad Details			
1.	On Key	6.	Soft Key 3
2.	Off Key	7.	Defrost Key
3.	Display Screen (5.7 inch)	8.	Cycle-Sentry Key
4.	Soft Key 2	9.	Accept/Enter Key
5.	Soft Key 1	10.	Navigation Keys (x4)

Hard Keys

There are four hard keys with dedicated functions.



ON Key: Used to turn the unit on.



Off Key: Used to turn the unit off.



Defrost Key: Press this key to initiate a Manual Defrost cycle.



CYCLE SENTRY Key: Used to select Cycle Sentry Mode or Continuous Mode operation.

Soft Keys

There are three soft keys. The function of soft keys change depending on the operation being performed.

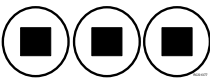

SOFT Keys: The three keys directly under the display are soft keys. The function of soft keys change depending on the operation being performed. If a soft key is active, its function will be shown in the display directly above the key.

Navigation Keys

There are four navigation keys that allow the operator to scroll up, down, left and right to view or make changes to a selected display.



UP Key: Used to scroll up through the display menu.



DOWN Key: Used to scroll down through the display menu.



LEFT Key: Used to scroll to the left of the display menu.



RIGHT Key: Used to scroll to the right of the display menu.

Accept/Enter Key

The center key is used to accept changes. It is also used to enter changes made by the operator.



ACCEPT/ENTER Key: Used to accept or enter changes.

Standard Display

The Standard Display is the “base” from which all other display operations are launched. The Standard Display appears after the unit startup sequence is completed.

Figure 11. Standard Display and Icon Descriptions Shown

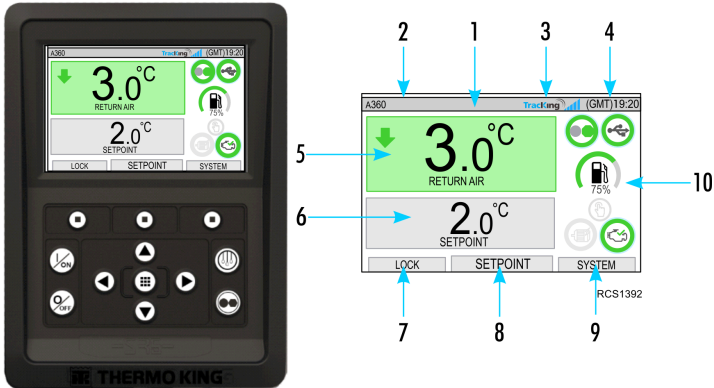

Standard Display and Icon Descriptions	
1.	Status Bar — Displays unit information across top of screen.
2.	Model Type/Specification — Displays unit type.
3.	TrackKing Signal — Displays telematics signal strength.
4.	Time w/Time Zone — Displays current time. Time Zone shows that you are now in a region +/- from the time shown.
5.	Trailer Temp — Displays actual box temperature.
6.	Setpoint — Displays temperature defined by user.
7.	LOCK — Is customizable in Main Menu Plus (Default screen is LOCK).
8.	SETPOINT — Used for critical functions.
9.	SYSTEM — Is customizable in Main Menu Plus.
10.	DASHBOARD - See Dashboard Section for details. (“Dashboard,” p. 39)

Temperature Watch Display

The Standard Display defaults to the Temperature Watch Display after about 2-1/2 minutes of non-use (when no keys are pressed) and no info, check or shutdown alarms are present. The Lock Symbol in the Display Dashboard signifies that the Display is locked.

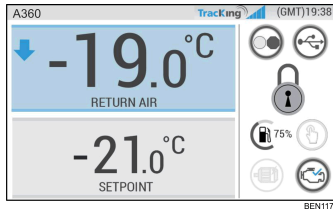

1. Press any key to enter the Unlock System Screen.

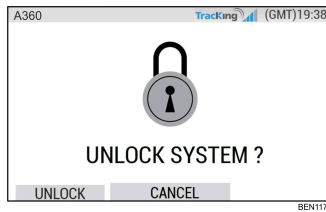

2. Verify by selecting "Unlock" at this screen.
3. You will then be returned to the Standard Display.

Dashboard

The Dashboard is located on the right of the Standard Display and is the hub for overall system operation. Similar to a car dashboard, all icons have a defined position and only become lit when active. This allows the operator to quickly identify the unit’s operating mode e.g., Continuous, Cycle-Sentry, Diesel or Electric.

Figure 12. Standard Display with Dashboard on Right Shown

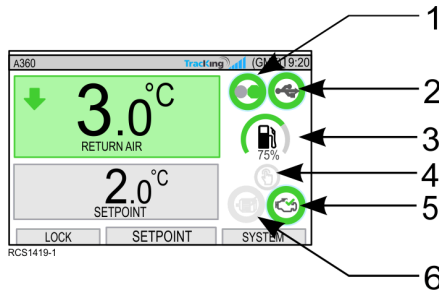

Dashboard Icons and Descriptions	
1.	Cycle-Sentry: This icon indicates the unit is operating in Cycle-Sentry Mode.
2.	USB Connection Status: This icon indicates a USB flash drive is connected to the A-Series Controller.
3.	Fuel Level: This icon indicates the trailer unit’s fuel in percentage (if applicable).
4.	<p>Auto- Switch: This icon indicates:</p> <ul style="list-style-type: none"> When lit, Auto-Switch Enabled feature is set to YES, allowing unit to switch automatically from Diesel Mode to Electric Mode when standby power is connected and available. Not lit, Auto-Switch Enabled feature is set to NO, keeping unit in Diesel Mode. A prompt screen (Yes/No) will appear when standby power is connected and available.
5.	Electric Operation: This icon indicates the unit is operating in Electric Mode (if applicable).
6.	Diesel Operation: This icon indicates the unit is operating in Diesel Mode.

Main Menu

The Main Menu contains several additional submenus that allow the operator to view information and modify unit operation.

To access the Main Menu press the ACCEPT/ENTER key.

Figure 13. Standard Display and Main Menu Display Shown



RCS1431

Use the UP, DOWN, LEFT or RIGHT keys to scroll through the menu choices. When the desired selection is shown, press the ACCEPT/ENTER key.

Once you have made your selection, again use the UP, DOWN keys and the ACCEPT/ENTER key to view information or modify unit operation.

When done, navigate to the BACK icon and press the ACCEPT/ENTER key to return to the Standard Display.

Note: Each of the Main Menu choices will be explained in detail later.

Operating Instructions

Turning Unit On

Note: *Microprocessor On/Off Switch must be in the “ON” position for unit to operate.*

Turn unit on by pressing the ON Key.

Note: *System startup sequence may take up to 60 seconds to configure.*

Diesel engine preheats and starts are automatic in both Continuous Mode and Cycle Sentry Mode. The engine preheat and start will be delayed in Cycle Sentry mode if there is no current need for the engine to run.

Note: *If Electric Standby is active, there may be some additional prompts before the engine will start.*

Figure 14. System Startup Sequence Shown

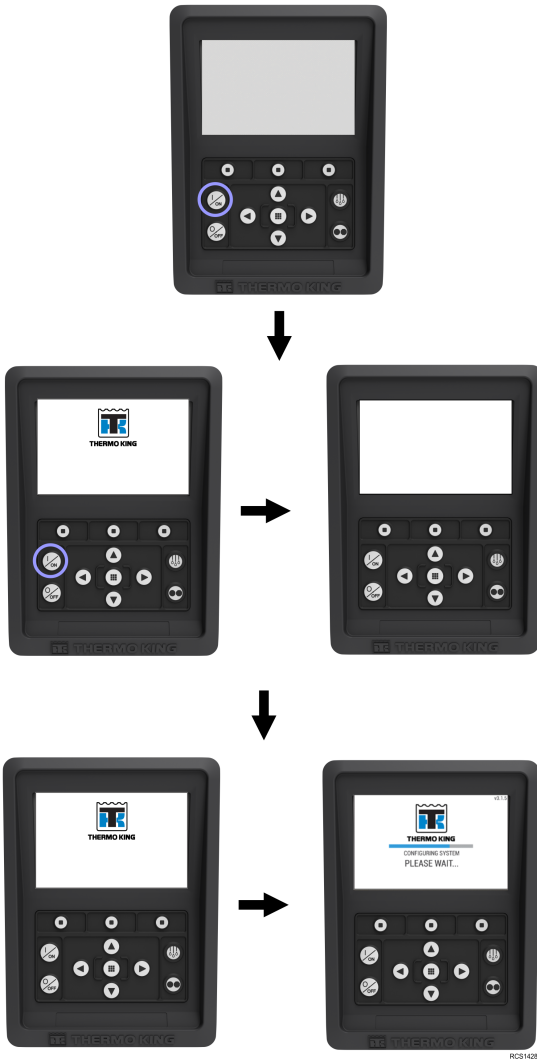

Once the system startup sequence is completed, the Standard Display will appear and unit will start in the Diesel Mode (if no Electric Standby is detected).

Note: *Operating Mode: The unit retains the last user configured operating mode when power cycled. i.e. If the unit was running in Continuous Mode, and then power is cycled, the unit would still remain in continuous mode.*

The temperature setpoint or other system changes can now be made if required.

Figure 15. Standard Display Showing - Unit Running in Diesel and Continuous Mode

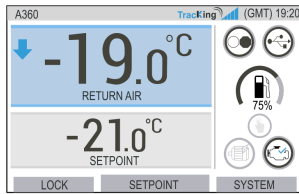

RCS1430

Turning Unit Off

Turn the unit off by pressing the OFF Key. When the off key is pressed, the display will briefly show "SYSTEM IS POWERING DOWN". After the power-down sequence is complete the display will be blank.

Note: *When the unit is turned off using the HMI Controller, no temperature control is available. If the unit is not going to be operated for one week or longer, placing the microprocessor on/off switch in the OFF position will help prevent parasitic battery voltage loss and a dead unit battery.*

Figure 16. System Powering Down Sequence Shown

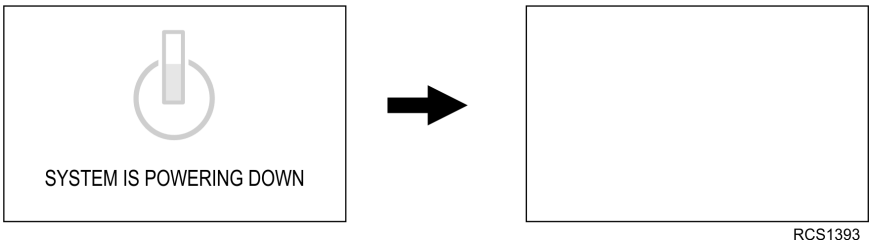

Language Selection

After turning the unit ON and the Configuring System is complete, the Language Selection display will appear (if set to ENABLED).

Note: English is the default language.

To change the language:

1. Use navigation keys to scroll to preferred language.
2. Press Accept/Change Key or Cancel.
3. The Standard Display with the chosen language will appear next.

Note: If no key is pressed in language prompt for 45 seconds then the current language will be retained.

Figure 17. Language Selection Displays Shown



If Language Selection does not appear on startup, then Language change is not activated. Once you follow the steps below, this will activate the language changer.

To change the language:

1. Access the MAIN MENU by pressing the Accept/Enter Key.
2. Use the arrow keys to access LANGUAGE.

THERMO KING

Operating Instructions

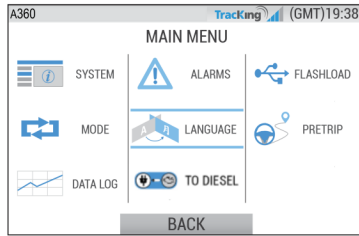

BEN1199

3. Use arrow keys to choose language and press the Accept/Enter Key.
4. Exit the Main Menu.

Operating Software

Flash Loading

Important: Only Thermo King supplied, specific operating software should be used and uploaded by a Thermo King Service Technician or damage to the operating system may result.

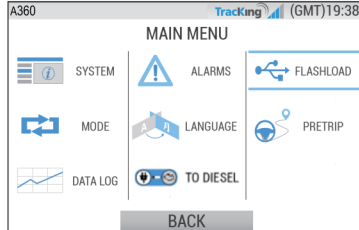

BEN1201

Continuous Mode

Note: The unit retains the last user configured operating mode when power cycled. i.e. If the unit was running in Continuous Mode, and then power is cycled, the unit would still remain in continuous mode.

1. With the unit operating and the Cycle-Sentry icon lit, press the Cycle-Sentry Key to initiate the Continuous Mode programming process.
 - After a few seconds, the Standard Display will return and Cycle-Sentry icon will no longer be lit.
 - The unit is now operating in Continuous Mode.

Figure 18. Initiating Continuous Mode



Figure 19. Continuous Mode Shown

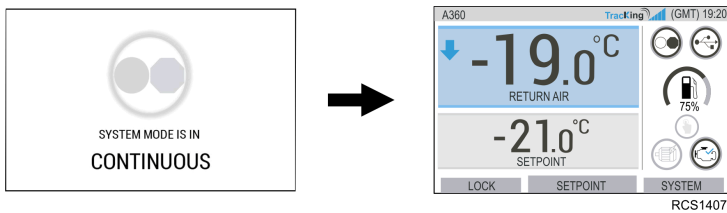

If the initiation failed, the unit will return to Cycle-Sentry Mode. Check for alarms and retry.

Figure 20. Failed Operation Display



Cycle-Sentry Mode

CYCLE-SENTRY is a Start-Stop fuel saving system that provides optimum operating economy. When CYCLE-SENTRY Mode is selected the unit will start and stop automatically to maintain setpoint.

1. With unit operating in Continuous Mode, press the Cycle-Sentry Key to initiate the programming process.

After a few seconds, the Standard Display will return and the Cycle-Sentry icon will be lit.

The unit is now operating in Cycle-Sentry Mode.

Figure 21. Initiating Cycle-Sentry Mode

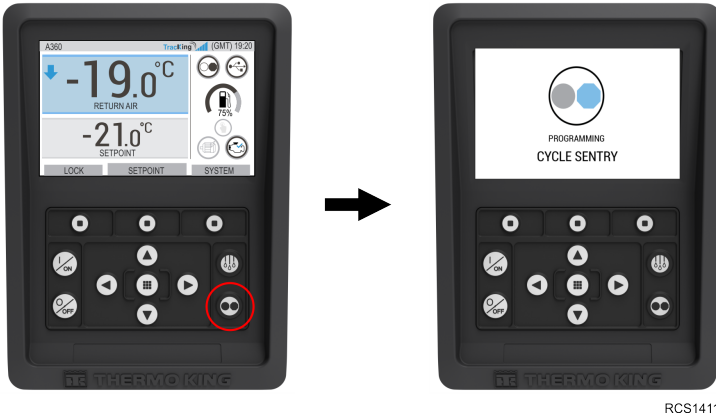

Figure 22. Cycle-Sentry Mode Shown



If the initiation failed, the unit will return to Continuous Mode. Check for alarms and retry.

Figure 23. Failed Operation Display



RCS1409

Fuel Gauge

Fuel gauge will display the trailer unit’s fuel in percentage if a fuel level sensor has been connected to the A-Series Controller. The percentage fuel level is shown on the A-Series Controller Display in the centre of the Dashboard. See below screen shows the fuel level at 75%.

Figure 24. Fuel Gauge Display

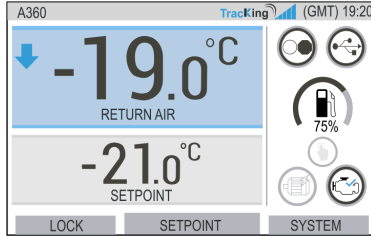

RCS1430

Switching from Diesel to Electric Operation

▲ CAUTION

Risk of Injury!

The motor may start automatically any time the unit is turned on.

Electric Power Receptacle: The electric power receptacle is used to connect the unit to an appropriate power source for electric standby operation. The receptacle is located next to the HMI Control Panel. Verify the unit and the power supply are turned off before connecting or disconnecting a power cord.

Automatic Switching from Diesel to Electric: Electric motor starting is automatic in both Continuous Mode and Cycle Sentry Mode when the Auto-Switching Enabled feature is set to **YES** and electric standby power is detected.

Manually Switching from Diesel to Electric: The unit will need to be manually switched to Electric Mode only when the unit is operating in Diesel Mode and Auto-Switching Enabled feature is set to **NO**.

To manually switch to Electric Mode:

1. Connect standby power cord to receptacle.
2. Turn standby power source on.
 - Electric Standby Detected will be displayed when electric standby power is connected and available to the unit while operating on diesel power.
3. Switch from diesel mode to electric mode by pressing Key 3 directly below the “YES” box.

Figure 25. Electric Motor Detection Display Shown

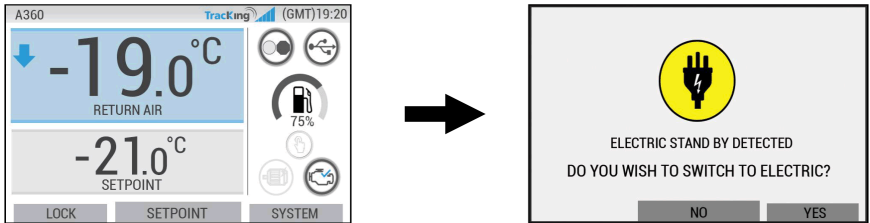

RCS1413

THERMO KING
Operating Instructions

The following will be displayed briefly.

Figure 26. Programming Electric Operation Display Shown



Switching from Electric to Diesel Operation

Diesel engine preheats and starts are automatic in both Continuous Mode and Cycle Sentry Mode. The engine will preheat and start as required when the unit is turned on. The engine preheat and start will be delayed in Cycle Sentry mode if there is no current need for the engine to run.

Note: *If the unit is equipped with optional Electric Standby there may be some additional prompts before the engine will start. Refer to "Electric Operation" for details.*

⚠ CAUTION

Risk of Injury!

The engine may start automatically any time the unit is turned on.

The unit can be manually switched to Diesel Mode while operating in Electric Mode.

To manually switch to Diesel Mode:

1. Press the ACCEPT/ENTER Key to enter the Main Menu and scroll to the diesel engine icon and press the accept key.

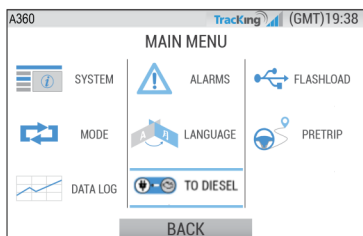

BEN1200

- HMI will display "PROGRAMMING DIESEL OPERATION", "DIESEL ENGINE STARTING".
- When diesel engine is running, the HMI will display "DIESEL ENGINE IS RUNNING" screen for 3 seconds and light diesel icon in dashboard.

Figure 27. Programming Diesel Operation Display Shown

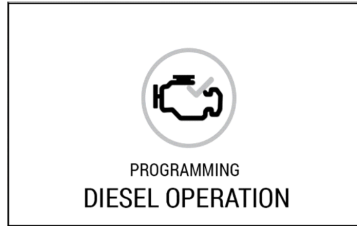

RCS1255

Figure 28. Electric Motor Icon Replaced By Diesel Engine Icon Shown

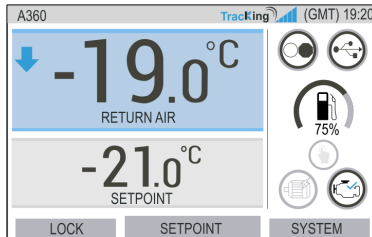

RCS1429

Changing the Setpoint

- Pressing Key 2 under SETPOINT will take you to the setpoint screen.



RCS1305

- Pressing the UP arrow key will increase the value by 1 until setpoint reaches to higher limit.
- Pressing the DOWN arrow key will decrease the value by 1 until setpoint reaches lower limit.
- Pressing and holding either the UP or DOWN arrow key will accelerate the values until released.
- Pressing Key 3 under CONFIRM will display “PROGRAMMING SETPOINT PLEASE WAIT”.
- If change is successful — HMI will display “SETPOINT CHANGED”.
- If change is unsuccessful — HMI will display “SETPOINT NOT CHANGED”.

Figure 29. Setpoint Display Shown



RCS1238

Defrost Mode

Defrost cycles are usually initiated automatically based on time and demand.

The operator can also initiate a manual defrost if necessary. Manual defrost is only available if the unit is running and the evaporator coil temperature is less than or equal to 45F (7C).

Note: Other features such as door switch settings may not allow manual defrost under certain conditions.

- If the defrost parameters are met — HMI will display “PROGRAMMING DEFROST” followed by UNIT IS DEFROSTING”.
- In Defrost Mode, the trailer temperature box will be replaced by defrost information and trailer temp box and dashboard will change its color to “purple”.
- Additionally, the return air temperature (trailer temp) will be replaced by the coil icon and a intermediate spinner on top with a display progress bar for the remaining defrost time across the bottom.

Figure 30. Defrost Mode Displays Shown

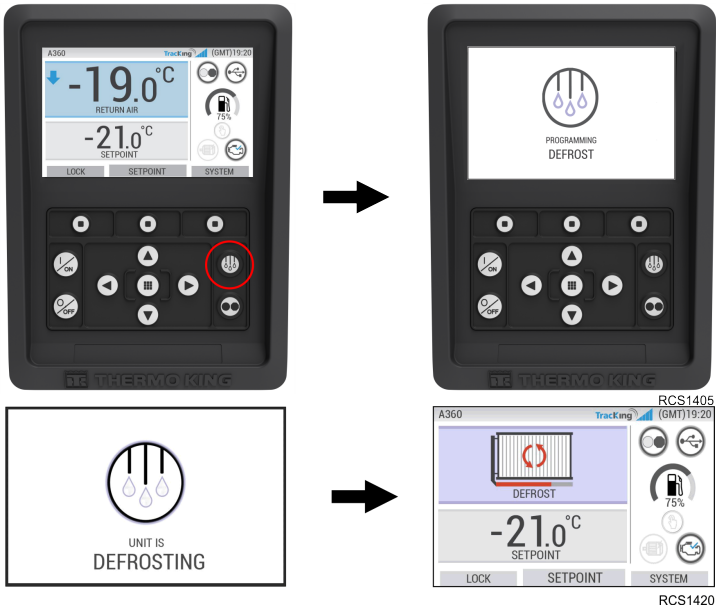

Operating Instructions

When the defrost is complete, the HMI will display “EXITING DEFROST” for 2 seconds and return to the standard display.

Figure 31. Defrost Complete Displays Shown

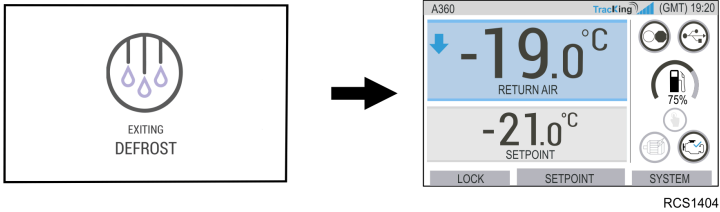

HMI will display “DEFROST NOT AVAILABLE” if the defrost parameters are not met.

Figure 32. Failed Defrost Display Shown

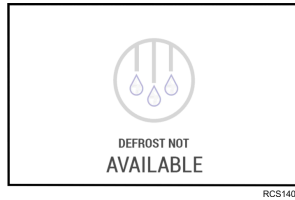

Frozen Mode

- The unit enters in to Frozen Mode when the trailer temperature is less than and equal to -4C or -40F by default. These limits can be changed in guarded access display.
- The TRAILER TEMP box and the dashboard (lit icons) will change to a “Blue” color which defines the trailer temperature zone as “Frozen”.
- The down pointing arrow at the left side of the display indicates the unit is cooling.

Figure 33. Frozen Mode Display Shown

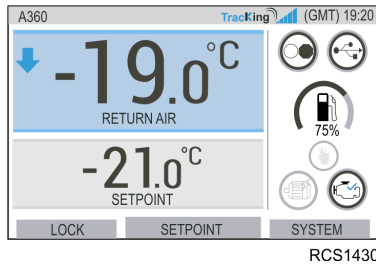

Fresh Mode

- The unit enters in to Fresh Mode when the trailer temperature is greater than -4C and less than and equal to 10C by default. This limits can be changed in guarded access display.
- The TRAILER TEMP box and the dashboard (lit icons) will change to a “Green” color which defines the trailer temperature zone as “Fresh”.
- The down pointing arrow at the left side of the display indicates the unit is cooling.

Figure 34. Fresh Mode Display Shown

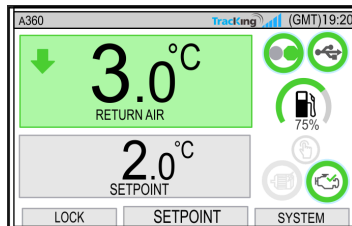

RCS1265

Heat Mode

- The unit enters in to Heat Mode when the trailer temperature is greater than 10C by default. This limits can be changed in guarded access display.
- The TRAILER TEMP box and the dashboard (lit icons) will change to a “Red” color which defines the trailer temperature zone as “Heat”.
- The up pointing arrow at the left side of the display indicates the unit is heating.

Figure 35. Heat Mode Display Shown

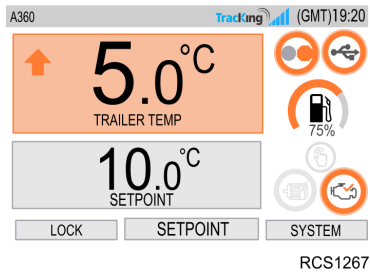

Null / Running Null

The unit will enter in to Null Mode after the trailer temperature reaches setpoint when operating in Cycle Sentry operating mode. In the null mode, the diesel engine will shut down, but the microprocessor will continue to monitor the trailer box temperature. If the temperature varies two degrees above or below setpoint, the diesel engine will automatically restart to bring the trailer box temperature back into range.

- The TRAILER TEMP box will change to a “Grey” color which defines the trailer unit as operating in “Null / Running NULL”.

Figure 36. Null Display Shown

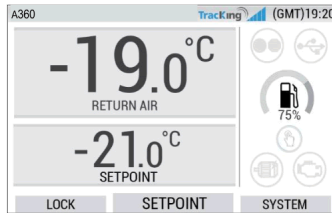

RCS1394

Alarms

The microprocessor continuously monitors the system performance and will generate a alarm code when it detects an abnormal condition. Alarms direct an operator or service technician to the source of a problem.

Multiple alarms can be present at one time. All generated alarms will be stored in memory until cleared by the operator or service technician. Document all alarm occurrences and report them to the service technician.

Important: *Always record any Alarm Codes that occur - in the order that they occur - as well as any other pertinent information. This information is extremely valuable to service personnel.*

SYSTEM REVIEW REQUIRED will be displayed to alert the operator that the unit has generated an alarm.

Figure 37. System Review Display Shown

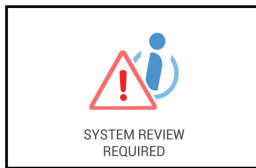

RCS1395

Three types of alarms may appear:

- **Information Alarms**
- **Check Alarms**
- **Shutdown Alarms**

Information Alarms

The INFORMATION icon will appear in the setpoint window.

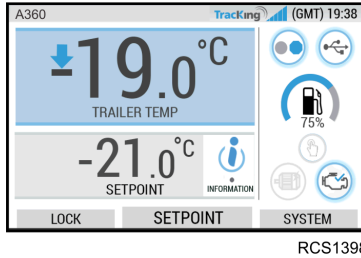

Check Alarms

CHECK ACTIVE icon will appear in the setpoint window.

Figure 38. Standard Display with Check Alarm Icon Shown

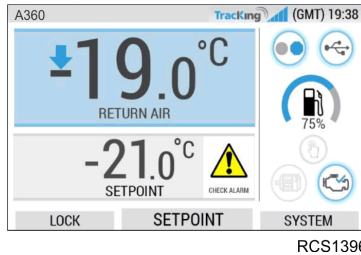

Shutdown Alarms

ALARM ACTIVE icon will appear on the center of the display and Temperature control will be disabled.

- TRAILER TEMP box and SETPOINT will be greyed out.
 - Soft key (1) will change to "Alarms" functionality.
 - Status bar and dashboard (lit icons) will change to a "Red" colour.
- If no action is taken, the ACTIVE ALARM icon will appear in the setpoint window.

Figure 39. Alarm Active and Alarm Information Displays Shown



RCS1397

Piek Active Mode

The PIEK ACTIVE Mode icon will appear in the setpoint window.
No change in the dashboard color when Piek Active mode is active.

Figure 40. Piek Active Icon Shown

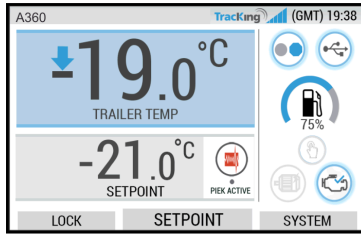

RCS1399

Main Menu+ Display

Details

The Main Menu+ Display includes additional system information available to the operator.

Figure 41. Main Menu+ Display Shown



RCS1241

Figure 42. Main Menu+ Alarm Display Shown



RCS1285

Figure 43. Main Menu+ System Status Display Shown

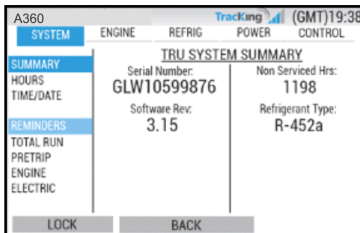

RCS1243

Connecting to a Third Party Device

All A-Series trailer units come equipped with dedicated device connection points for external devices. Only these connection points must be used as they prevent battery discharge/depletion of the EnergyONE battery during unit idle periods. The Location of the Power Connections are shown below. Please refer to your third party device connection instructions for more information.

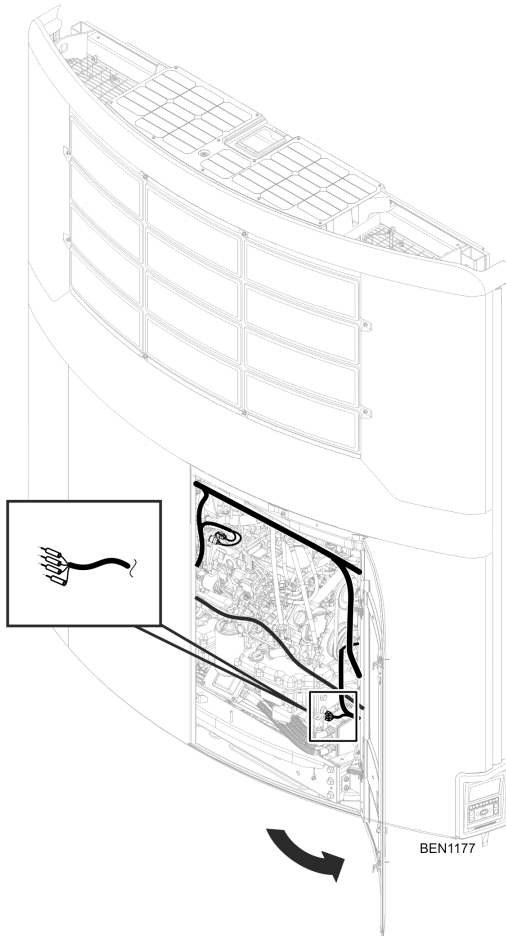

Printing a Trip Report

The optional Thermo King TouchLog datalogger printer allows you to print a record of such things as the unit microprocessor controller identification numbers, dates and times, the setpoint, and the data from the optional Compliance Log sensors . If no sensors are connected, the printed record shows the same information without the sensor data.

1. Locate the printer connector - located inside the unit door (close to the A-Series Controller) as shown below.

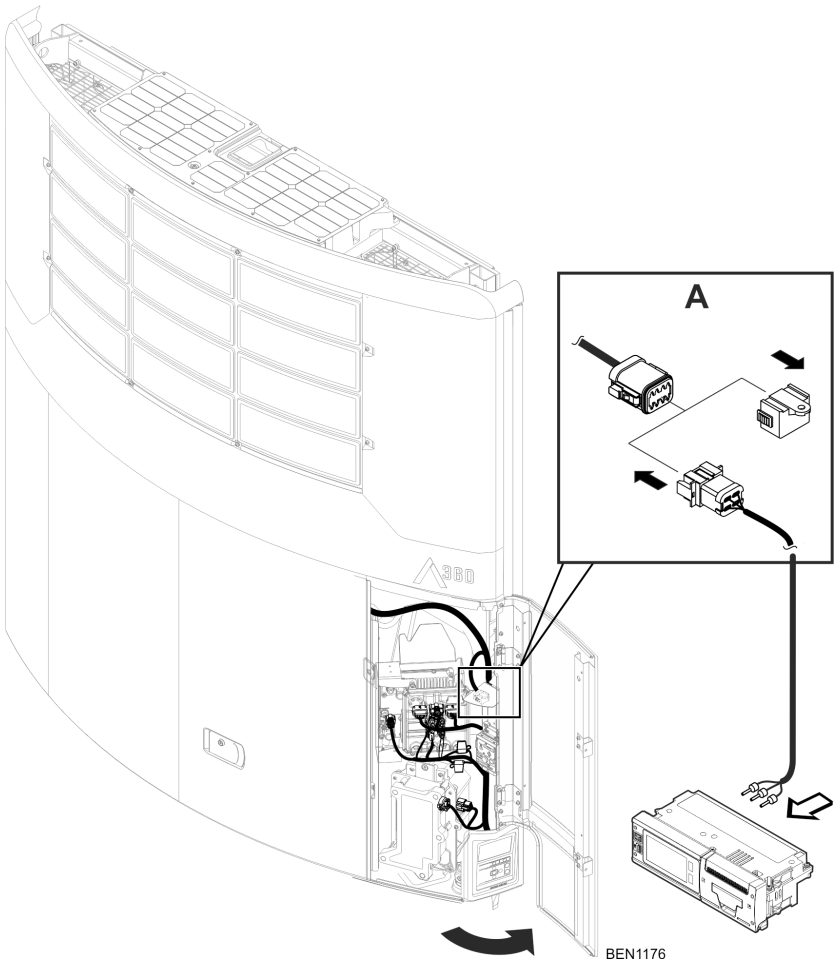

Operating Instructions

2. Remove the connector cover.
3. Connect the Printer Connector (From Printer harness) to this Printer Connector.
4. Connect the spliced wires on the other end of the Printer Harness into the connection location at the back of the Printer.
5. Please refer to your TK 61009-11-OP TouchPrint Operator Manual at [EMEA Operator Manual Website](#)(or third party printer manual) for instructions for setup and use.

Note: *For additional information concerning the TouchPrint Printer or TouchLog Datalogger contact your Thermo King dealer.*

Loading and Inspection Procedures

This chapter describes pre-loading inspections, loading procedures, post-loading procedures, post-loading inspections, and enroute inspections. Thermo King refrigeration units are designed to maintain the required product load temperature during transit. Follow these recommended loading and enroute procedures to help minimize temperature related problems.

Pre-Loading Inspection

1. Pre-cool products before loading. Note any variances on the manifest.
2. Inspect door seals and vent doors for condition and a tight seal with no air leakage.
3. Inspect the trailer inside and out. Look for:
 - Damaged or loose trailer skin and insulation
 - Damaged walls, air ducts, floor channels, or “T” flooring
 - Clogged defrost drain tubes
 - Blocked return air bulkhead
4. Verify that the setpoint temperature is correct for your cargo. Pre-cool the trailer as required.
5. Supervise product loading to ensure sufficient air space around and through the load. Airflow around cargo must not be restricted.

Note: *If the warehouse is not refrigerated, operate the unit with the doors closed until cargo is ready to be loaded. Then turn off the unit, open the cargo doors and load cargo. When cargo is loaded, close trailer doors and restart the unit. The unit can be operated with the cargo box doors open if the truck is backed into a refrigerated warehouse and the dock door seals fit tightly around the trailer.*

Figure 44. Loading Considerations

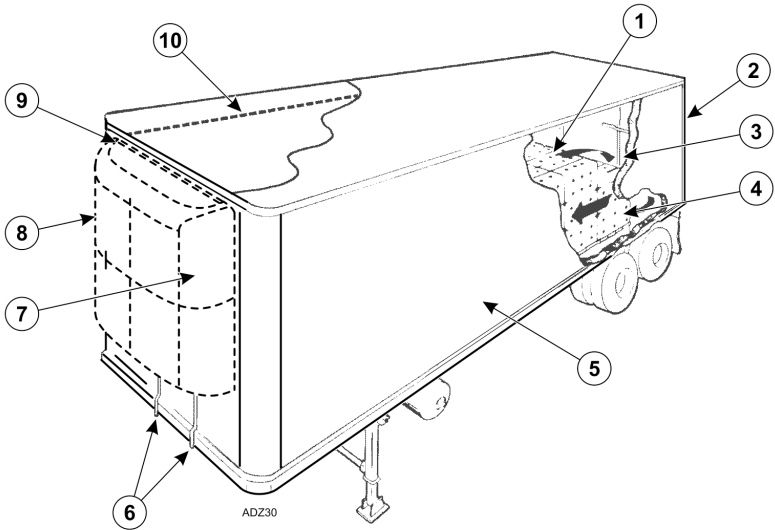

1.	Correct load height (trailers without chutes)	6.	Clear defrost drains
2.	Tight doors and seals	7.	Good outside air circulation
3.	Good air circulation around load	8.	Unit inspection
4.	Proper cargo temperature (prior to loading)	9.	Tight seals
5.	Interior/exterior walls and insulation in good condition	10.	Maximum load height followed

Post-Loading Inspection

Post-loading inspections verify the cargo has been loaded properly. To perform a post-load inspection:

1. Inspect the evaporator outlets for blockage.
2. Turn the unit off before opening the cargo box doors to maintain efficient operation.

Note: *The unit can be operated with the cargo box doors open if the truck is backed into a refrigerated warehouse and the dock door seals fit tightly around the trailer.*

3. Perform a final check of the load temperature. If the load is above or below temperature, make a final notation on the manifest.

Important: *Cargo must be pre-cooled to proper temperature before loading. The unit is designed to maintain temperature, not cool an above-temperature load.*

4. Close or supervise the closing of the cargo box doors. Verify they are securely locked.
5. Verify the setpoint is at the temperature listed on the manifest.
6. If the unit was stopped, restart using the correct starting procedure. See the Operating Instruction chapter in this manual.
7. Start a manual defrost cycle 30 minutes after loading. See the Manual Defrost procedure in the manual.

Enroute Inspections

Complete the following enroute inspection every four hours. This will help minimize temperature related problems.

Inspection Procedure

1. Verify setpoint is correct.
2. Check the return air temperature reading. It should be within the desired temperature range.
3. Initiate a manual defrost cycle after each enroute inspection.

Inspection Troubleshooting

1. If a temperature reading is not within the desired temperature range, refer to the troubleshooting table ([Table 4, p. 76](#)). Correct problem as required.

Loading and Inspection Procedures

2. Repeat the Enroute Inspection every 30 minutes until the compartment temperature is within the desired temperature range. Stop the unit if the compartment temperature is not within the desired temperature range on two consecutive 30 minute inspections, especially if the compartment temperature appears to be moving away from the setpoint.
3. Immediately contact the nearest Thermo King Dealer or your company office.
4. Take all necessary steps to protect and maintain proper load temperature.

NOTICE

Cargo Loss!

Stop the unit if the compartment temperature remains higher than the desired temperature range from the setpoint on two consecutive 30 minute inspections. Contact the nearest Thermo King Dealer or your company office immediately. Take all necessary steps to protect and maintain proper load temperature.

Table 4. Inspection Troubleshooting

Problem: A return air temperature reading is not within desired temperature range of the setpoint.	
Cause	Remedy
The unit has not had time to cool down to correct temperature.	Refer to the load log history. Look for above temperature load records, properly pre-cooled cargo compartment, length of time on road, etc. Correct as required. Continue monitoring return air temperature until the reading is within the desired temperature range of the setpoint. <i>Note: Ensure cargo is properly pre-cooled prior to loading onto trailer. If 'warm cargo' is loaded onto trailer and reefer is used to cool to setpoint this will result in longer time required to cool down to correct temperature and possibly plugging of evaporator with frost due to increased humidity in trailer compartment.</i>
The unit may have a low refrigerant charge.	Check the receiver tank sight glass for refrigerant level. If fluid is not showing in the receiver tank sight glass, the refrigerant charge may be low. A competent refrigeration technician is required to add refrigerant or repair the system. Contact the nearest Thermo King dealer, authorized Service Center, or call the Thermo King Cold Line for referral. Consult the Table of Contents for Cold Line information.
The unit is in defrost or has just completed a defrost cycle.	Monitor the return air temperature after the defrost cycle is completed to see if the temperature returns to the desired temperature range of the setpoint.

Loading and Inspection Procedures

Table 4. Inspection Troubleshooting (continued)

Problem: A return air temperature reading is not within desired temperature range of the setpoint.	
Cause	Remedy
The evaporator is plugged with frost.	Initiate a manual defrost cycle. The defrost cycle will automatically terminate when complete. Continue monitoring the return air temperature until the reading is within the desired temperature range of the setpoint.
Improper air circulation in the cargo compartment.	Inspect the unit and cargo compartment to determine if the evaporator fan (3) are working properly circulation the air. Poor air circulation may be due to improper loading of the cargo, shifting of the load, or depending on unit, fan belt slippage or faulty electrical fans. Correct as required. Continue monitoring return air temperature until problem is corrected.
The unit did not start automatically.	Determine the cause for not starting. Correct as required. Continue monitoring return air temperature until reading is within desired temperature range of the setpoint.
Multi-Temp Units Only – The unit is being used to cool/heat a single temperature load and does not have the capacity to cool the entire trailer.	A multi-temperature unit may not have the cooling or heating capacity to maintain a specific temperature range throughout an entire trailer.

Specifications

Engine

Model: A-360 A-400 and A-500	Thermo King TK486VMGS5 (NRMM Stage V compliant) Thermo King TK486VEGS5 (NRMM Stage V compliant)
Fuel Type	Diesel fuel must conform to EN590
Oil Capacity	12.3 liters/litres (13 quarts) crankcase and oil filter Fill to full mark on dipstick
Oil Type	Petroleum Multi-grade Oil: API Type CI-4, ACEA Class E3 Synthetic Multi-grade Oil: API Type CI-4, ACEA Class E3 (after first oil change)
Recommended Oil Viscosity (based on ambient temperature)	-10 C to 50 C (14 F to 122 F): SAE 15W-40 (Synthetic) -15 to 40 C (5 to 104 F): SAE 15W-40 -15 to 40 C (5 to 104 F): SAE 10W-30 (Synthetic or Synthetic Blend) -25 to 40 C (-13 to 104 F): SAE 10W-40 -25 to 30 C (-13 to 86 F): SAE 10W-30 -30 to 50 C (-22 to 122 F): SAE 5W-40 (Synthetic) Below -30 C (-22 F): SAE 0W-30 (Synthetic)
Nominal Engine RPM	A-360: 1200 and 1450 RPM A-400: 1050, 1200 and 1450 RPM A-500: 1050, 1200, 1450 and 1900 RPM
Engine Coolant Thermostat	71°C

TK THERMO KING
Specifications

Engine Coolant Type	<p>Conventional Coolant: Conventional coolant (antifreeze) is green or blue-green. GM 6038M or equivalent, low silicate antifreeze mixture, 50/50 antifreeze/water mixture, not to exceed 60/40.</p> <p>Important: <i>Do not mix conventional coolant and ELC. ELC (Extended Life Coolant): ELC is red. Units containing ELC have an ELC nameplate on the expansion tank. Use a 50/50 concentration of any of the following equivalents: Texaco ELC (7997, 7998, 16445, 16447), Havoline Dex-Cool® (7994, 7995), Havoline XLC for Europe (30379, 33013), Shell Dexcool® (94040), Shell Rotella (94041), Saturn/General Motors Dex-Cool®, Caterpillar ELC, Detroit Diesel POWERCOOL® Plus</i></p>
---------------------	---

NOTICE

System Contamination!

Do not add "GREEN" or "BLUE-GREEN" conventional coolant to cooling systems using "RED" Extended Life Coolant, except in an emergency. If conventional coolant is added to Extended Life Coolant, the coolant must be changed after 2 years instead of 5 years.

NOTICE

Equipment Damage!

Do not use high silicate automobile antifreeze.

Coolant System Capacity	5.3 liters/litres (5.6 quarts)
Radiator Cap Pressure	0.83 bar (12 psi) (88 kPa)
Drive	Direct to compressor clutch and belt from electric motor/generator, and belt to water pump.

Specifications**Filters**

Engine Oil Filter	EMI 3000 Hour – P/N 11-9182
Fuel Filter	EMI 3000 Hour – P/N 11-9342
Air Filter	EMI 3000 Hour – P/N 11-9955

Refrigeration System

Contact your Thermo King dealer for refrigeration system service or maintenance.

Electrical Control System

Low Voltage	12.8 Vdc to 48 Vdc 17–36 Vac
Battery	Thermo King EnergyONE (880 CCA) AGM battery as standard.
Fuses	See your Thermo King Dealer
Battery Charging	Single Temperature as Standard - 12 volt, 37 amp, brush type, Thermo King Alternator Single Temperature Option - 12 volt, 120 amp, brush type, Thermo King Alternator

Electric Motor

Size/Type	Operating Speed	Voltage/Phase/Hertz	Full Load Amps
9.3 kW Induction	1450 RPM	400 Volt, 3 phase, 50 hertz	19.7 amps
9.5 kW Induction	1740 RPM	460 Volt, 3 phase, 60 hertz	17.1 amps

Standby Power Requirements

Power Supply Circuit Breaker	400/3/50 460/3/60	32 ampere 32 ampere
Power Cord Size	400/3/50	Up to 15m, 6mm ² Over 15m, 10mm ²

	460/3/60	Up to 15m, 10mm ² Over 15m, 16mm ²
--	----------	---

TrackKing

Platform	ARM Cortex-A8, 300MHz, 256MB RAM, 4GB Flash, Linux
GSM/GPRS	3G, Sierra HL8548
GPS	u-blox NEO-7M
Bluetooth	Version 4.0 Bluetooth Classic /Bluetooth Low Energy (BLE)
Serial Ports	2 External Serial Ports for TrackKing extensions or Third-Party Connect
Input Power	12V Nominal
Backup Battery	Single cell Li-Ion 3.7V Nominal, > 2Ah
Environmental Storage Temperature	-40 to +85 C

Jump Starting

If unit battery is discharged or run down, unit may be jump started using jumper cables and another battery or vehicle. Consider the following precautions and be careful when jump starting a unit.

⚠ WARNING

Personal Protective Equipment (PPE) Required!

A battery can be dangerous. A battery contains a flammable gas that can ignite or explode. A battery stores enough electricity to burn you if it discharges quickly. A battery contains battery acid that can burn you. Always wear goggles or safety glasses and personal protective equipment when working with a battery. If you get battery acid on you, immediately flush it with water and get medical attention.

⚠ CAUTION

Hazard of Explosion!

Unhook the semi tractor from the trailer before using the tractor to jump start the unit on the trailer. The negative ground circuit is complete when the tractor is hooked to the trailer. This can cause dangerous sparks when the positive connection is made at the battery.

Important: *Make sure to use a 12 volt battery to jump start unit. If you are using a vehicle, make sure it has a 12 volt battery with a negative ground system. Do not use a "hot shot" booster device or a 24 volt source.*

Read and understand the following procedure completely before connecting and jumper cables. Use good jumper cables made with #2 gauge (or larger) cables.

1. Verify unit is turned off. If you are using a vehicle, verify its ignition is also turned off.
2. Open front doors on unit. Battery is located to the left of engine.
3. Check discharged battery to verify it is not damaged or frozen. Do not jump start a damaged or frozen battery. Check vent caps to verify they are tight.
4. Identify positive (+) and negative (-) battery terminals.
5. Remove red cover from positive (+) battery terminal on the unit's battery.

Figure 45. Sequence for Connecting Jumper Cables

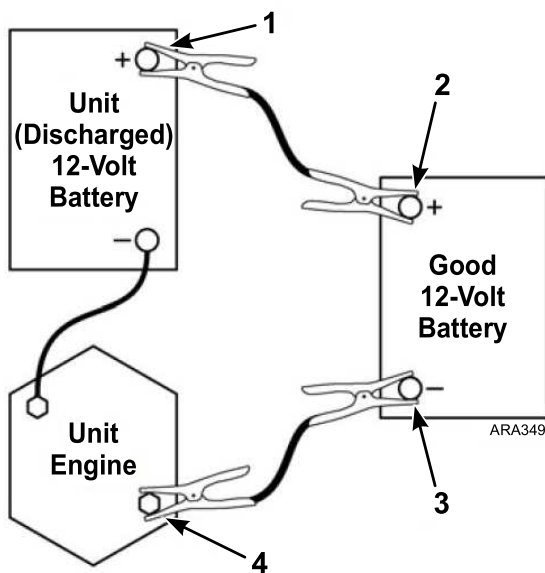

1.	Positive (+) Terminal on Unit Battery
2.	Positive (+) Terminal on Good Battery
3.	Negative (-) Terminal on Good Battery
4.	Starter Mounting Bolt on Unit Engine

6. Connect the red positive (+) jumper cable to the positive (+) battery terminal on the unit's battery. Do not let the other end of the jumper cable touch anything that conducts electricity.

⚠ WARNING

Hazard of Explosion!

Allowing the positive (+) jumper cable to short to ground can produce dangerous sparks.

7. Connect the other end of the red positive (+) jumper cable to the positive (+) battery terminal on the good battery.

Jump Starting

8. Connect the black negative (-) jumper cable to the negative (-) battery terminal on a good battery. Do not let the other end of the jumper cable touch anything that conducts electricity.

⚠ WARNING

Hazardous Voltage!

DO NOT connect to the positive connection on the starter motor, which is located on the top right of the starter motor.

9. Connect the black negative (-) jumper cable to the lower starter mounting bolt on the unit's engine.
10. If you are using a vehicle to jump start the unit, start the vehicle and let it run for a few minutes. This will help charge the discharged battery.

⚠ DANGER

Risk of Injury!

Keep your hands, clothing, and tools clear of fans and/or belts when working on a unit that is running or when opening or closing compressor service valves. Loose clothing might entangle moving pulleys or belts, causing serious injury or possible death.

11. Turn the unit on and let it start automatically or start it manually. If the unit will not crank or start, contact a qualified technician.

Note: *Some units with microprocessors will show an alarm code and will not try to start the unit until battery voltage is above 10 volts.*

12. After the unit starts, remove the jumper cables in reverse order: black negative (-) from the unit starter mounting bolt, black negative (-) from the good battery, red positive (+) from the good battery, and red positive (+) from the unit battery (that was discharged).

Figure 46. Sequence for Disconnecting Jumper Cables

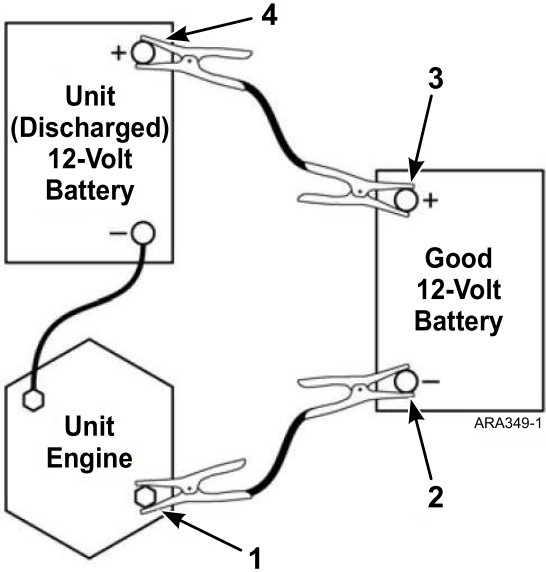

1.	Starter Mounting Bolt on Unit Engine
2.	Negative (-) Terminal on Good Battery
3.	Positive (+) Terminal on Good Battery
4.	Positive (+) Terminal on Unit Battery

Warranty

Terms of the Thermo King Trailer Unit warranty are available on request from your local Thermo King dealer.

Maintenance Inspection Schedule

Inspection and Service Intervals

Inspection and Service intervals are determined by the number of unit operating hours and by the age of the unit. Examples are shown in the table below. Your Dealer will prepare a schedule to suit your specific needs.

Service Record: Each inspection and service performed should be recorded on your Dealer Service Record.

Interim Inspection	Complete PM	Full Service
A Service Every 1500 hours or every 12 months (whichever comes first)	B Service Every 3000 hours or every 24 months (whichever comes first)	C Service Every 6000 hours or every 48 months (whichever comes first)

Pretrip	Inspect/Service These Items
•	Run Pretrip Test
•	Check fuel supply
•	Check and adjust coolant/engine oil levels
•	Listen for unusual noises, vibrations, etc.
•	Visually inspect unit for fluid leaks. (fuel, coolant, oil and refrigerant)
•	Visually inspect unit for damaged, loose or broken parts (includes air ducts and bulkheads if so equipped)
•	Visually inspect belt(s)
<p>Note: For further best practices, please go to www.europe.thermoking.com/best-practices.</p>	

Recover Refrigerant

At Thermo King®, we recognize the need to preserve the environment and limit the potential harm to the ozone layer that can result from allowing refrigerant to escape into the atmosphere.

We strictly adhere to a policy that promotes the recovery and limits the loss of refrigerant into the atmosphere.

In addition, service personnel must be aware of Federal regulations concerning the use of refrigerants and the certification of technicians. For additional information on regulations and technician certification programs, contact your local THERMO KING dealer.

Thermo King – by Trane Technologies (NYSE: TT), a global climate innovator – is a worldwide leader in sustainable transport temperature control solutions. Thermo King has been providing transport temperature control solutions for a variety of applications, including trailers, truck bodies, buses, air, shipboard containers and railway cars since 1938. For more information, visit www.thermoking.com or www.tranetechnologies.com.

Thermo King has a policy of continuous product and product data improvements and reserves the right to change design and specifications without notice. We are committed to using environmentally conscious print practices.